

Inverse Pressure Relief Valve

Model Code

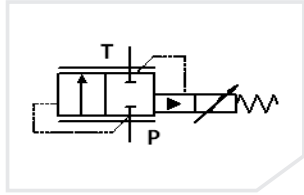

Flow Characteristics

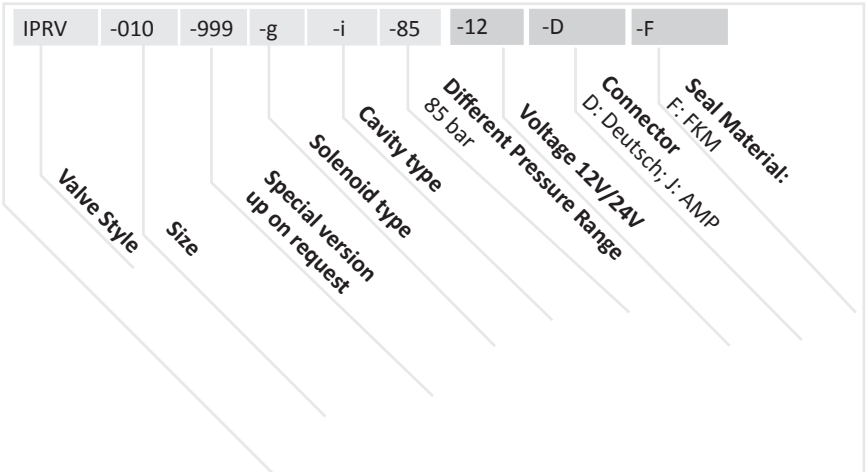
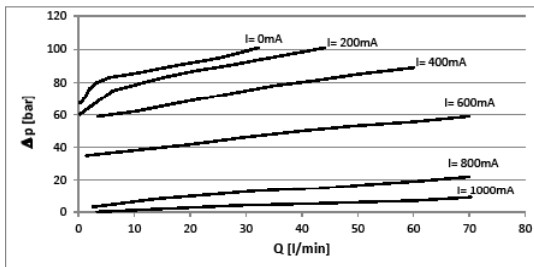

Hydraulic Data

Max Pressure (P , T)	pP = 150bar , pT = 35bar
Contamination Level	Min Filtration: 18/15/13 according to ISO 4406
Fluid	Mineral oil according to DIN 51524
Temperature Range Fluid	-20°C to +90°C
Nominell Flow	40l/min
Flow Range	5l/min - 70l/min
Valve specification according to Thomas LHP-85	

Electrical Data

Voltage	12V	24V
Current	1200 mA	600 mA
Resistance	5,3 Ω ± 5%	21.2 Ω ± 5%
Protection Class	up to IP65 / IPX7	
Connector	1) Deutsch Connector DT04-2P 2) AMP Junior Timer	

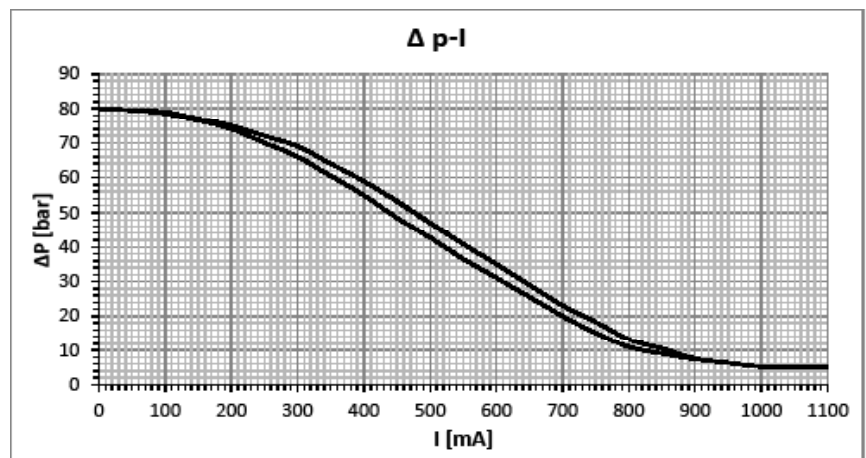

Inverse Pressure Relief Valve

Dimensions with Deutsch Connector (All dimensions in mm)

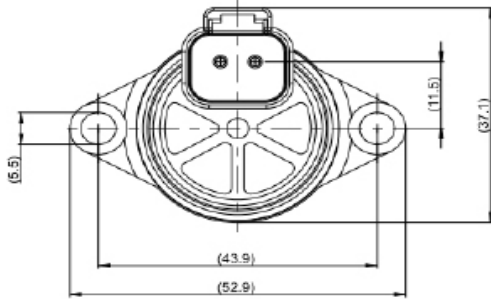

Cavity Dimensions (All dimensions in mm)

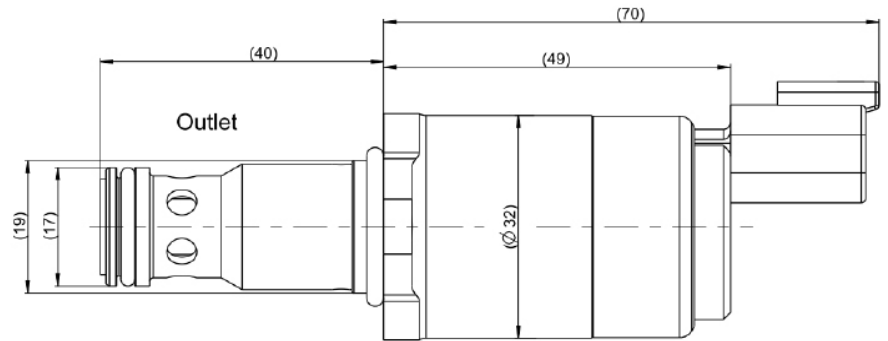

Cavity Dimensions (All dimensions in mm)

Cavity According Specification: TC06025

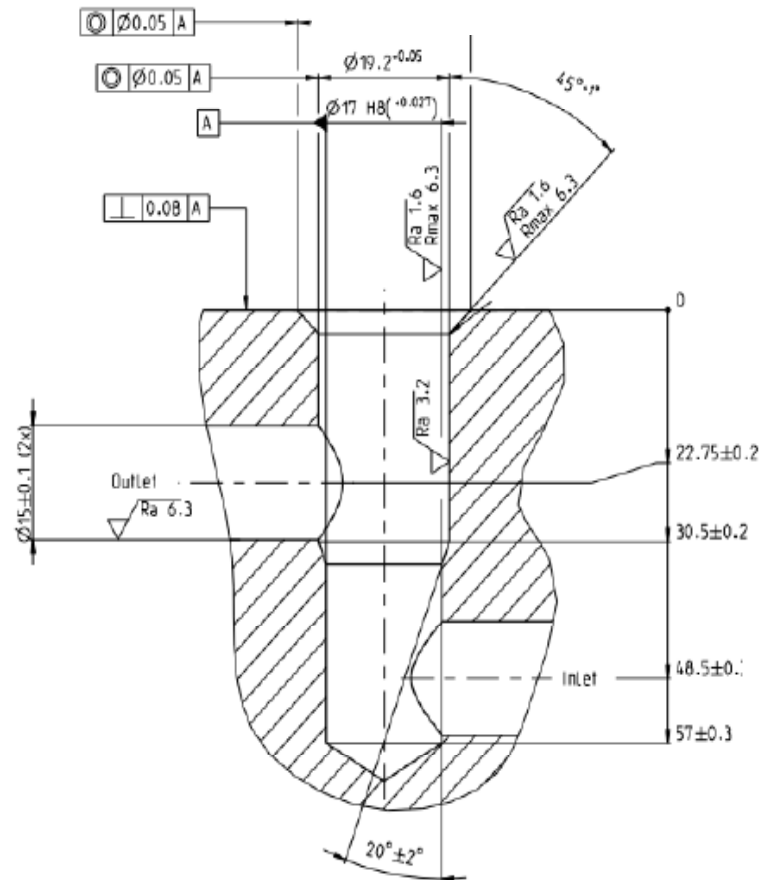

Thomas Magnete GmbH
San Fernando 35, 57562 Herdorf
Germany

Tel . +49 (0) 2744 929 0
Fax +49 (0) 2744 929 290

www.thomas-magnete.com
info@thomas-magnete.com



The presented information is based on current knowledge and provides only non-binding information to the customer. Any liability in connection with this information is excluded. It is the responsibility of the customer to determine the suitability and appropriateness of the product for his intended purpose. We reserve the right to change the product with regard to technical progress and new developments.