

Proportional Pressure Control Valve PPCD05–NG PPRV

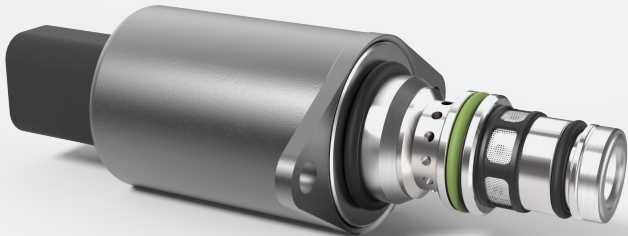

PRODUCT CLASSIFICATION

Proportional valves

Directional valves

Smart products

Special designs

Name Max volume flow @ 6 bar dp

Name	Max volume flow @ 6 bar dp	
PPCD 03	1,25 l/min	Direct controlled
PPCD 04	2,5–5 l/min	
PPCD 05	10 l/min	
PPCD 06	15 l/min	
PPCD 08	20 l/min	
PPCD 09	30 l/min	
PPCP 09	35 l/min	Pilot operated
PPCP 13	72 l/min	

HYDRAULIC DATA

Max pressure pump	$P_p = 50$ bar
Max pressure tank	$P_T = 30$ bar
Max pressure work	$P_A = 30$ bar
Hysteresis	< 3 % of the nominal pressure at recommended type of control
Contamination level	Min Filtration: X/20/18 According to ISO 4406
Fluid	Mineral Oil According to DIN 51524
Temperature range fluid	-30°C to +105°C
Leakage (internal)	< 0,03 l/min (de-energized) < 0,25 l/min (energized)
Filterscreen size	140 μ m (P-Port)

ELECTRICAL DATA

Voltage	12 V	24 V	
Max current	1500 mA	750 mA	
Resistance	4,72 $\Omega \pm 5\%$	8,15 $\Omega \pm 5\%$	20,8 $\Omega \pm 5\%$
Type of control	PWM signal > 1000 Hz + superimposed dither 120 Hz (200 mA peak to peak) recommended		
Connector	AMP Junior timer Deutsch Connector DT04-2P		
Protection class	up to IP6K6 / IPX9K		
Switching time	$t_{on} < 40$ ms (pA = 0% to 90%) $t_{off} < 40$ ms (pA = 100% to 10%)		

* The reported data are measured @ $P_p=41$ bar and an oil viscosity of 32 cSt

CURRENT VS. PRESSURE (AVERAGE CHARACTERISTIC)

P-I CURVE (12 V_4,72 Ω)

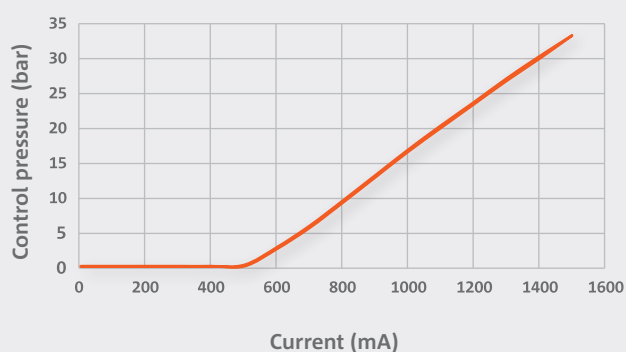

P-I CURVE (24 V_8,15 Ω / 24 V_20,8 Ω)

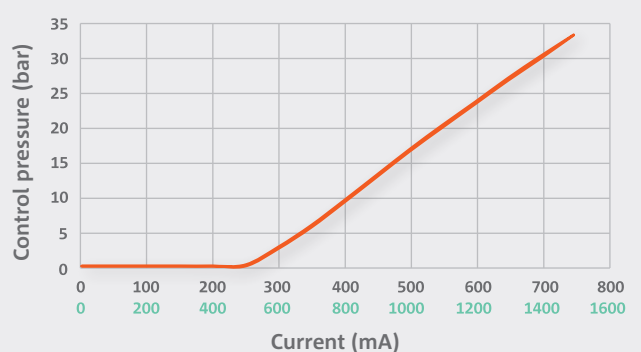

FLOW CHARACTERISTICS (AVERAGE CHARACTERISTIC)

PRESSURE DROP PUMP TO CONTROL PORT (P→A)

Valve only

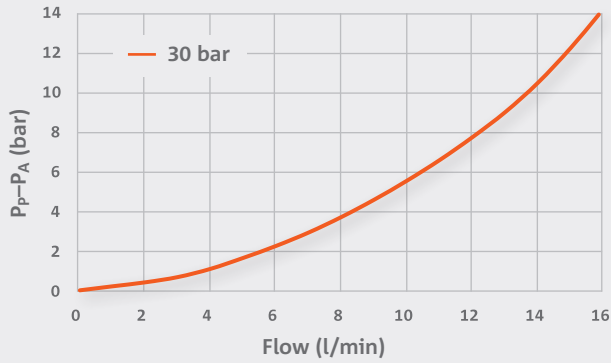

PRESSURE DROP CONTROL PORT TO TANK (A→T)

Valve only

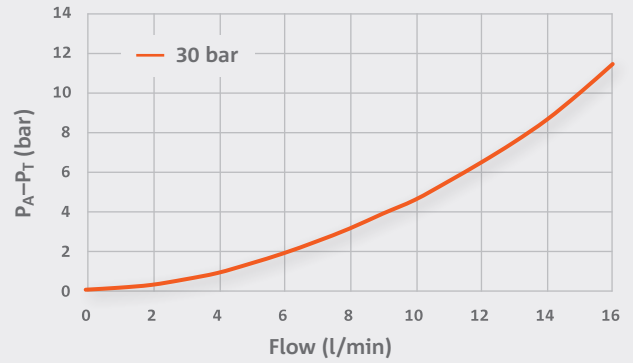

HYDRAULIC SCHEMATIC

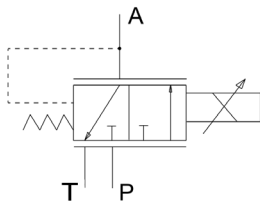

ADDITIONAL DATA

Weight	approx. 235 g
Mounting position (recommended)	any
MTTF_d-value	150 years
Reference	Valve specifications according to Thomas LHP 86

DIMENSIONS WITH DEUTSCH CONNECTOR* (All dimensions in mm)

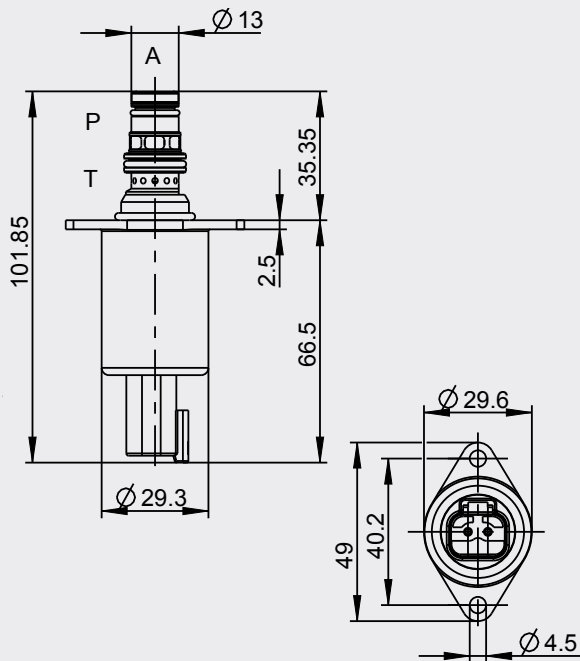

CAVITY DIMENSIONS (All dimensions in mm)

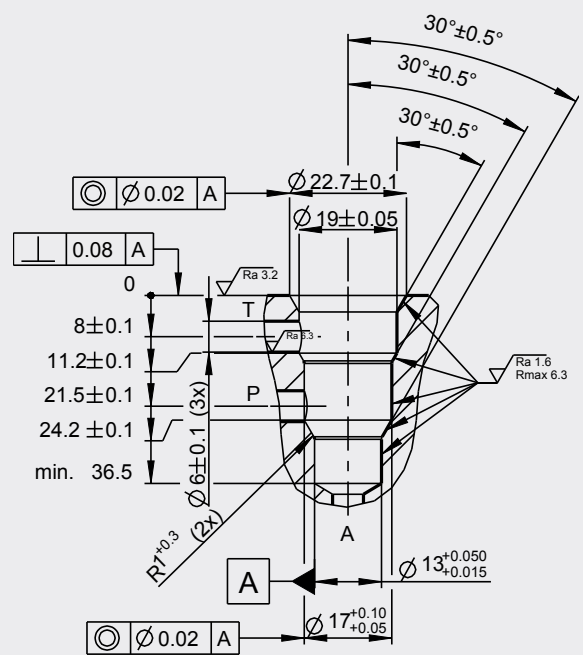

* Dimensions for AMP Jr. Connector available on request.

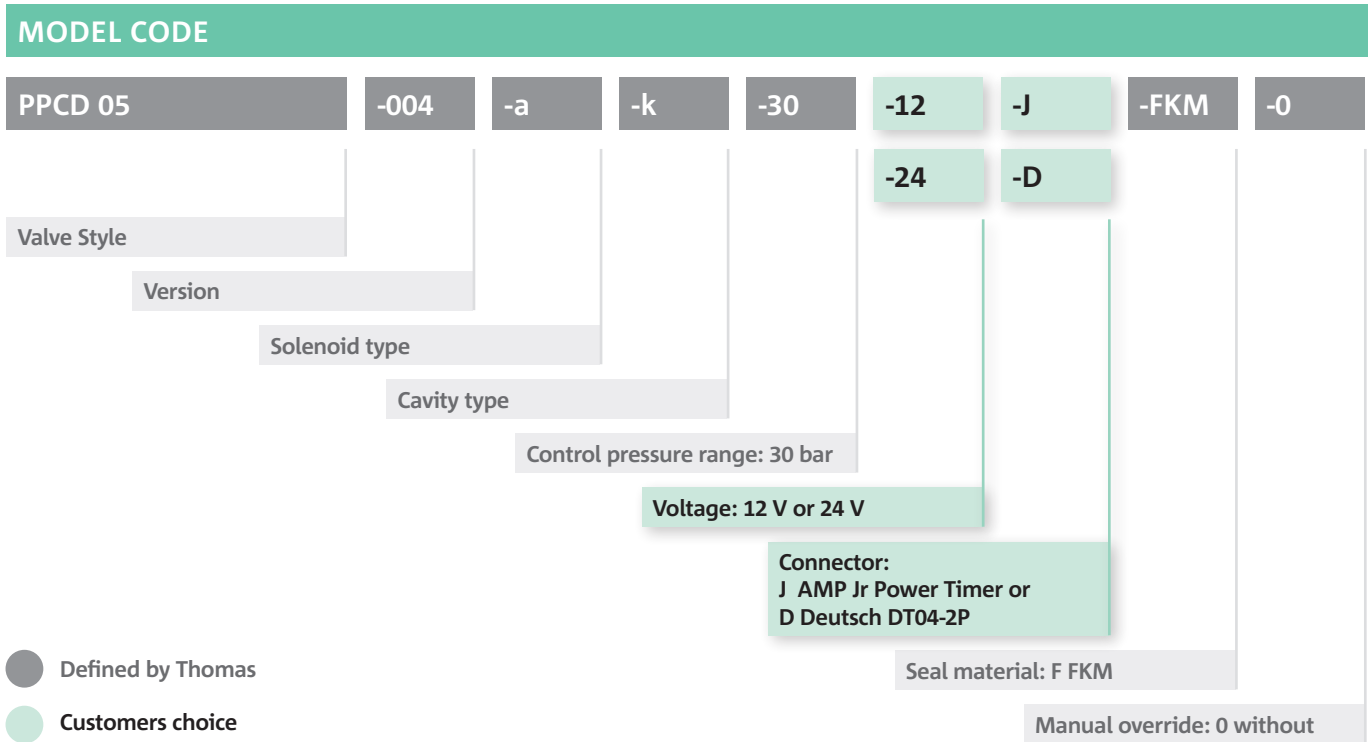

CONTACT DETAILS

Michael Lutz

Thomas Magnete GmbH

- ✉ Innomotion Park 3
57562 Herdorf, Germany
- ☎ Tel. +49 2744 929-220
- 📧 michael.lutz@thomas-magnete.com
www.thomas-group.com

DISCLAIMER

The presented information is based on current knowledge and provides only non-binding information to the customer. Any liability in connection with this information is excluded. It is the responsibility of the customer to determine the suitability and appropriateness of the product for his intended purpose. We reserve the right to change the product with regard to technical progress and new developments.