

Directional Control Valve DCSD05 – On/Off NG

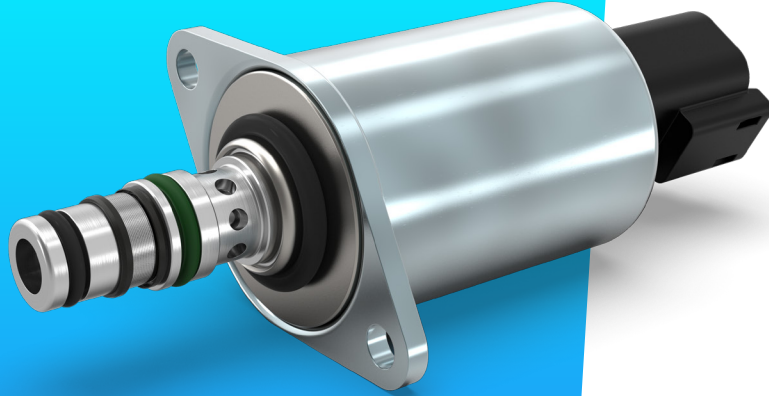

Product classification

Name	Max volume flow @ 6 bar dp
DCSD 04	7 l/min
DCSD 05	10 l/min
DCSD 06	15 l/min
DCSD 09	30 l/min

Proportional
valves

**Directional
valves**

Smart
products

Special
designs



Hydraulic Data

Max pressure pump	$P_p = 50$ bar (30 bar in case of manual override)
Max pressure tank	$P_T = 30$ bar
Max pressure work	$P_A = 50$ bar
Contamination level	Min Filtration: 20/18/15 According to ISO 4406
Fluid	Mineral Oil According to DIN 51524
Temperature range fluid	-30°C to +105°C
Leakage (internal)	< 0,05 l/min (de-energized) < 0,05 l/min (energized)
Filterscreen size	125 µm (P-Port)

* The reported data are measured @ $P_p=50$ bar and an oil viscosity of 32 cSt

Electrical Data

Voltage	12 V	24 V
Resistance (DT04)	8,15 Ω ± 5%	32,5 Ω ± 5%
Resistance (AMP)	4,72 Ω ± 5%	20,8 Ω ± 5%
Current range	0 to 1500 mA	0 to 750 mA
Voltage supply	9 to 16 V	18 to 32 V
Type of control	Current control PWM 180 Hz recommended Direct voltage control possible for high resistance coil	
Connector	AMP Junior timer Deutsch Connector DT04-2P	
Protection class	up to IP6K6 / IPX9K	
Switching times	$t_{on} < 60$ ms (pA = 0% to 90%) $t_{off} < 100$ ms (pA = 100% to 10%)	

Switching limits (average characteristic)

Switching limit for port assignment type j

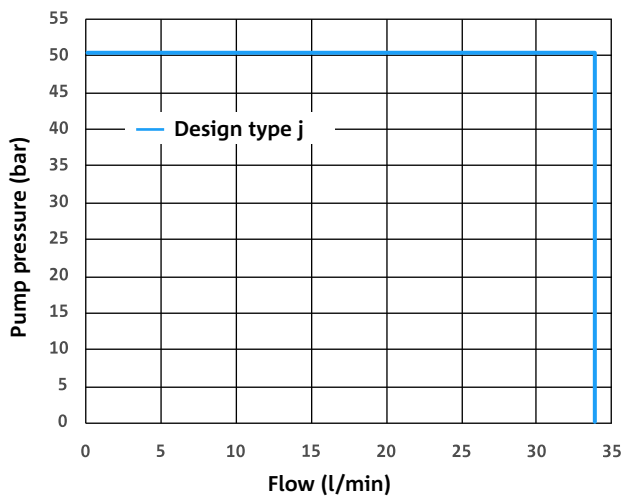

Additional data

Weight	approx. 175 g
Mounting position (recommended)	any
MTTF _d -value	150 years
Reference	Valve specifications according to Thomas LHP 84



Flow characteristics (Average characteristic)

PRESSURE DROP AT DE-ENERGIZED STATE

Valve only

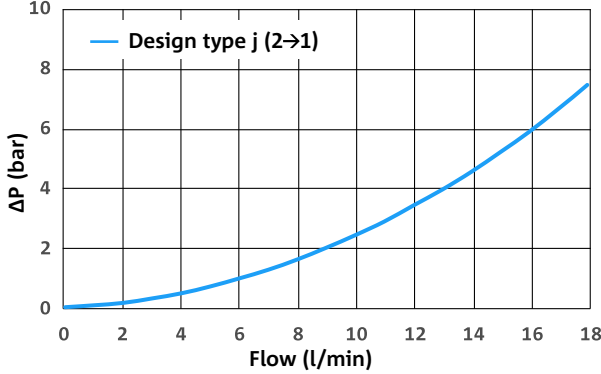

PRESSURE DROP AT ENERGIZED STATE

Valve only

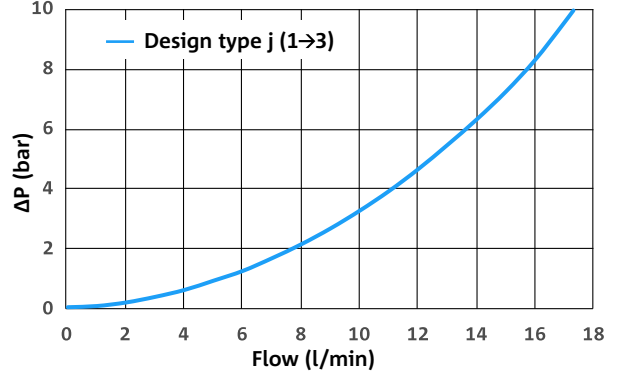

Design type j

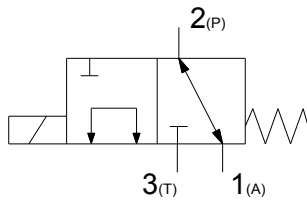

Dimensions with Deutsch Connector* (All dimensions in mm)

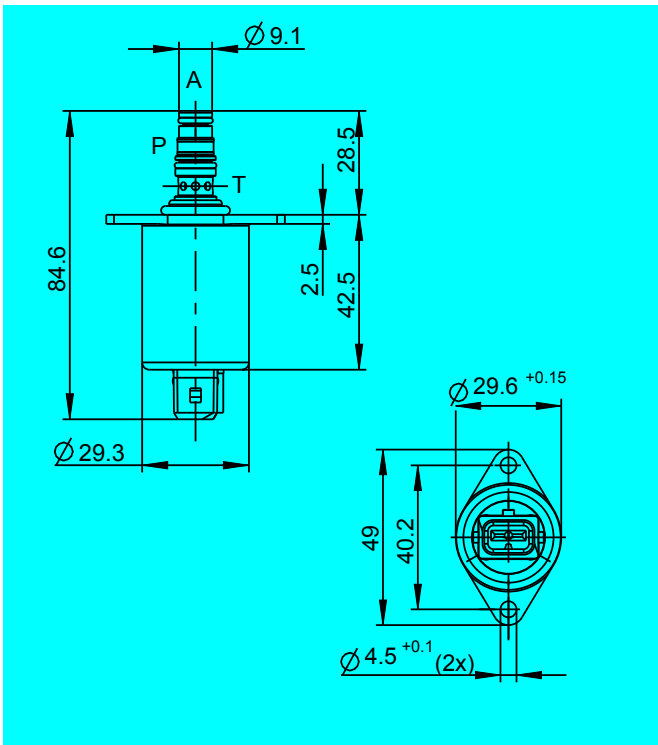

Cavity Dimensions (All dimensions in mm)

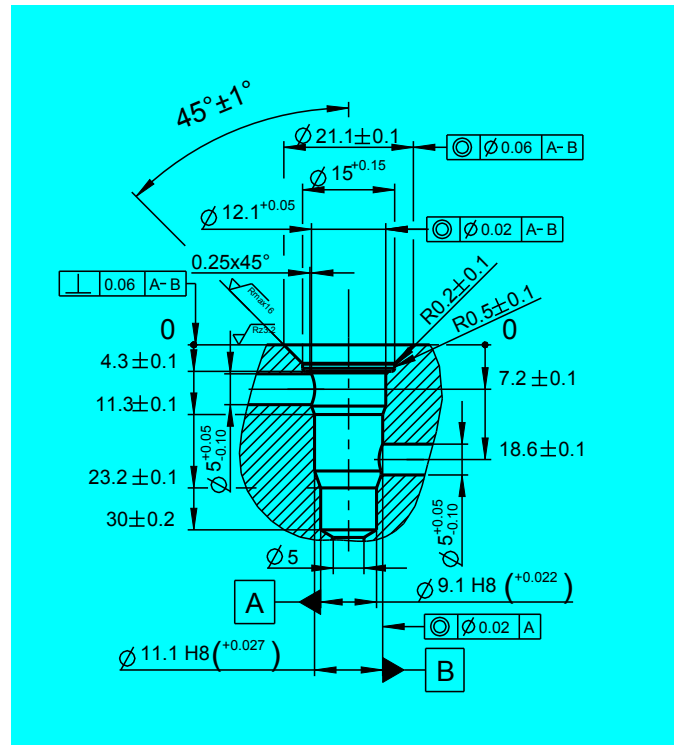

* Dimensions for Deutsch Connector DT04-2P available on request.



Model code

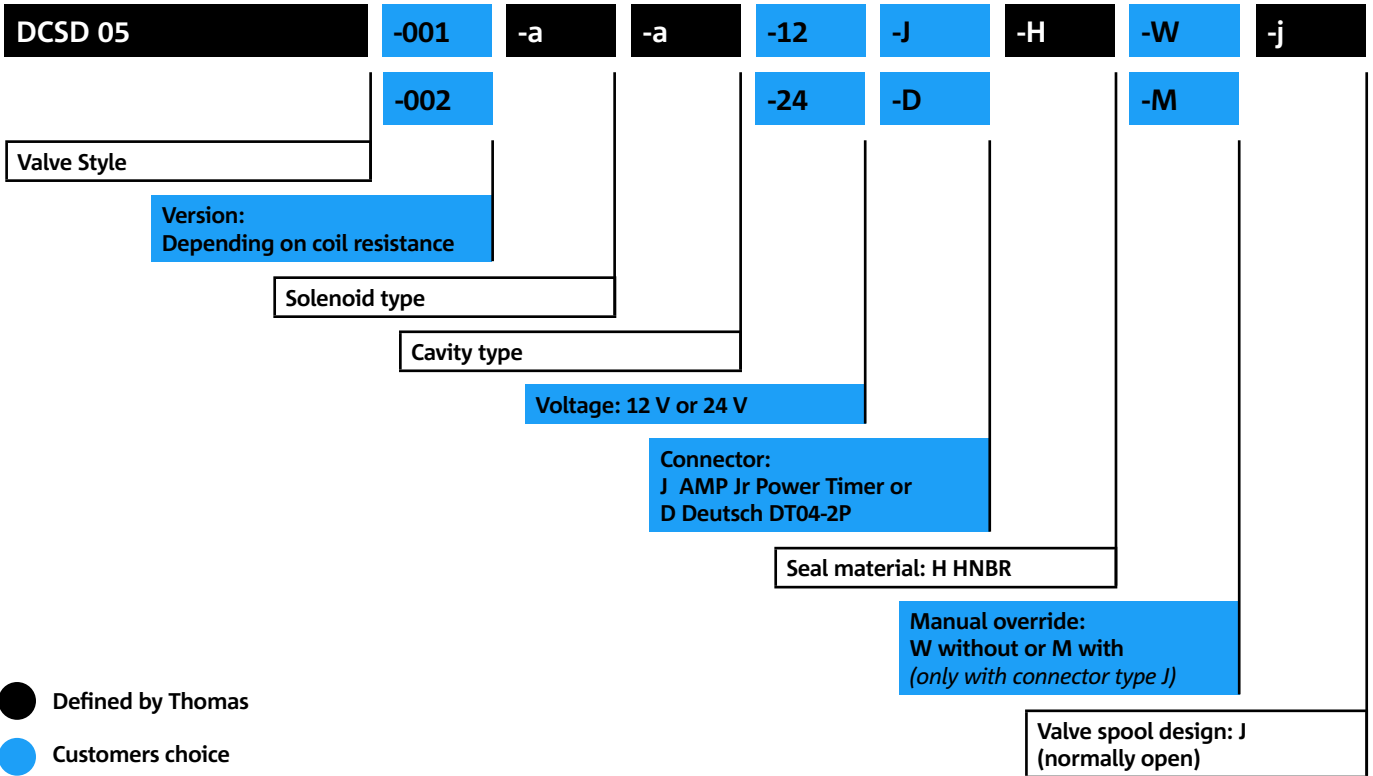

- Defined by Thomas
- Customers choice

CONTACT DETAILS

Michael Lutz

Thomas Magnete GmbH

Innomotion Park 3
57562 Herdorf, Germany

Tel. +49 2744 929-220

michael.lutz@thomas-magnete.com

www.thomas-group.com

DISCLAIMER

The presented information is based on current knowledge and provides only non-binding information to the customer. Any liability in connection with this information is excluded. It is the responsibility of the customer to determine the suitability and appropriateness of the product for his intended purpose. We reserve the right to change the product with regard to technical progress and new developments.